

Please keep this manual for future reference.

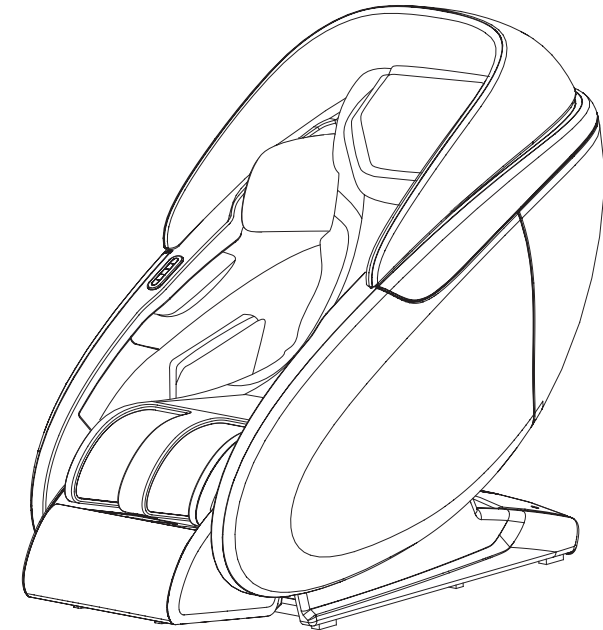

## User Manual

## Troubleshooting

If you notice any abnormal functions or sounds, please turn off the massage chair and unplug it from the outlet. Please contact Kyota™ for technical support.

Problem	Solution
The massage chair is connected to power but is not functioning.	<ol style="list-style-type: none"> <li>1. Check to see if the power plug is inserted properly or if the power outlet is functioning properly.</li> <li>2. Check to see if the main power switch is in the "I" position.</li> </ol>
The remote controller is responding, but the massage chair is not functioning.	The massage chair may have automatically shut down due to overheating protection devices. Please turn off the power and allow the chair to cool off for 30-50 minutes.
Both the remote controller and massage chair are not responding.	The massage chair automatically turns into "full stop" or into "idle" mode when a massage program is completed. Please press the power button again to turn on the chair.
The power button on the shortcut keys is not responding.	Press and hold the power button until the power up/ power down process begins. The button must be held down to prevent accidental shut down if hit unintentionally.

## Table of Contents

Safety Precautions	.....	2
Product Specifications	.....	4
Product Components	.....	5
Chair Installation	.....	7
Before Use	.....	8
Operation Guide	.....	9
Maintenance	.....	19
Troubleshooting	.....	20

Please read and follow all safety and operating instructions listed in this user manual before use. Please keep the user manual handy for future reference.

## Safety Precautions

### Warning!

Prior to using your massage chair, please read all the operational and safety guidelines.

The power plug must be fully inserted into an appropriate outlet. Do not modify the plug or remove the grounding which may damage the massage chair.

1. Please make sure the plug is inserted into the proper outlet to reduce the risk of short circuits and fires.
2. Unplug the massage chair's power cord before cleaning or after using.
3. Do not use the massage chair in wet environments (i.e., bathroom, outdoors).
4. Do not place the massage chair in areas with exceptionally high temperatures or in direct sunlight.
5. Do not use the massage chair if the power cord is damaged. If you notice any damage to the plug or cord, please contact Kyota's technical support team immediately for assistance and repair. Please do not attempt to replace the power cord yourself.
6. People suffering with any type of illness or condition should consult a doctor before use.
7. Children and disabled individuals should be supervised at all times when using the massage chair.
8. If you feel any discomfort or pain during or after use of the massage chair, please refrain from using the chair and consult your doctor.
9. Do not attempt to move the chair by pulling the power cord.
10. Do not stand on the massage chair.
11. When moving the massage chair, please follow the instructions provided to avoid structural damage.
12. When using the massage chair, make sure there are no children, pets, or objects nearby, behind, or in front of the chair, as it could cause damage or injury when in motion.
13. Do not modify your massage chair, as this will void your warranty. Please contact Kyota directly for assistance.
14. This massage chair is intended for personal, household use only.

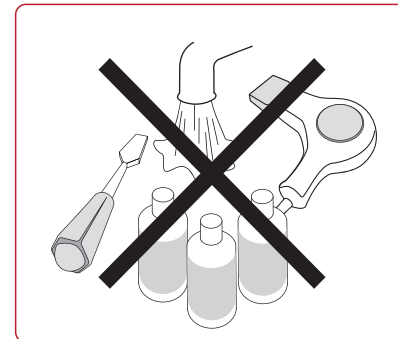
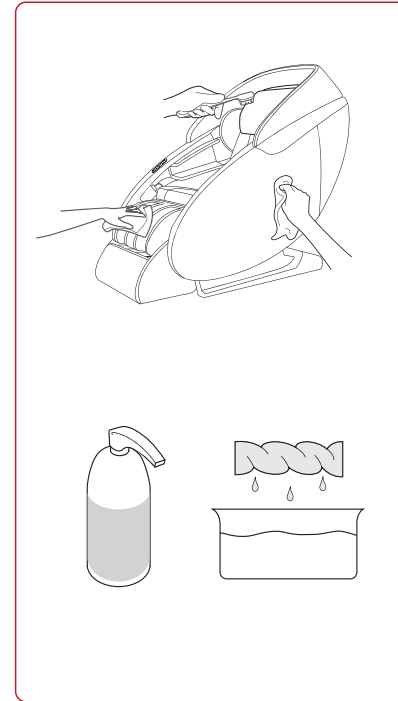

## Maintenance

- Unplug the power before cleaning.
- Do NOT pour any liquids directly onto the chair. Spray or dampen a soft cleaning cloth.
- Use a non-toxic cleaner and a dry cloth to clean the chair.
- Be sure the chair is completely dry before connecting to power.
- Do NOT use any drying machines (e.g.: hair dryer) to dry the areas cleaned. Only air dry to avoid any damage to the chair.
- Do NOT use any products containing benzene or alcohol to clean the chair.

# Operation Guide

# Safety Precautions

## 6. How to Use the Bluetooth Function to Play Music

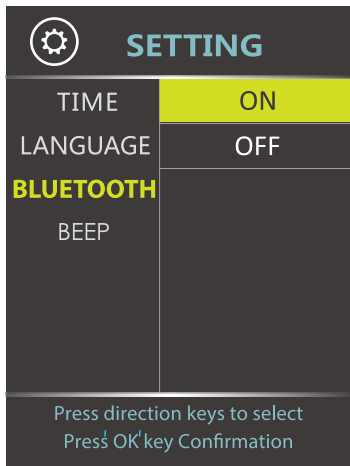

- A. Pair: Go to your mobile or tablet device's Bluetooth settings, and search for nearby Bluetooth devices. Choose the "M680-18080001" if required.
  - Please note that the number after "M680" will vary, as it will be the last eight digits of your chair's serial number.
- B. Play Music: After pairing the chair with your device, simply use your phone or tablet's music app to play the tunes of your choice.

- 15. Always check the surface of the massage chair before use. If you find any tears or damage on the cloth of the backrest, stop using the massage chair and contact Infinity for repair.
- 16. Consult your doctor prior to use if you have a heart condition or a pacemaker.
- 17. Do not massage any swollen or irritated parts of the body.
- 18. Do not operate the massage chair in areas where aerosol products are used or where oxygen is being administered.
- 19. This massage chair heats up during operation; therefore, those sensitive to heat should use extra caution when using the chair. The heat function can also be turned on or off based on your preference.

## 7. After Use

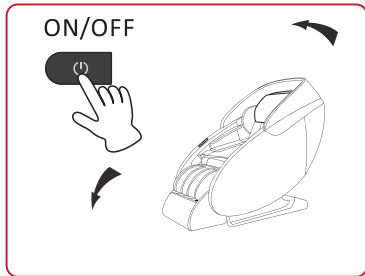

- 1. After your massage chair is complete, press the ON/OFF button on either the remote or the shortcut keys (if using the shortcut keys, be sure to press and hold the power button until shut down begins). The chair will automatically reset. Please check the surrounding area prior to adjusting the chair, paying close attention to children or pets who may be in close proximity. Also ensure your arms and legs are away from the gaps between the armrest, legrest, and footrest, in order to prevent possible pinching or injury.

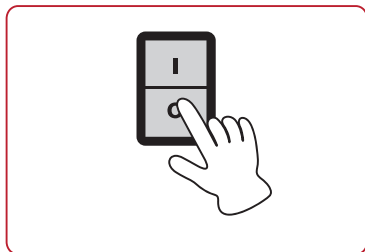

- 2. Press the power button to turn off the massage chair and place the remote controller in the storage box.
- 3. Remove the plug from the outlet.
  - \* Please do not pull on the power cord to remove the plug, or remove the plug with wet hands.

## Product Specifications

Description	Specifications
Model	Kyota Kaizen M680 3D/4D Massager Chair
Rated Voltage	110V~
Rated Frequency	60Hz
Rated Power Consumption	300W Max.
Dimension (LxWxH)	Main Body: 51.97x29.76x34.45in. 1320x756x875mm
	Side Panels: 69.69x29.37x20.87in. 1770x746x530mm
	Foot: 22.83x21.46x20.87in. 580x545x530mm
Weight	Main Body :N.W.: 84/185.19 KGS/LBS G.W.: 97/213.85 KGS/LBS
	Side Panels :N.W.: 36/79.37 KGS/LBS G.W.: 45.5/100.31 KGS/LBS
	Foot: N.W.: 25/55.12 KGS/LBS G.W.: 27.5/60.63 KGS/LBS
Max. User Weight	330 lbs

## Operation Guide

### 5. Display Diagram

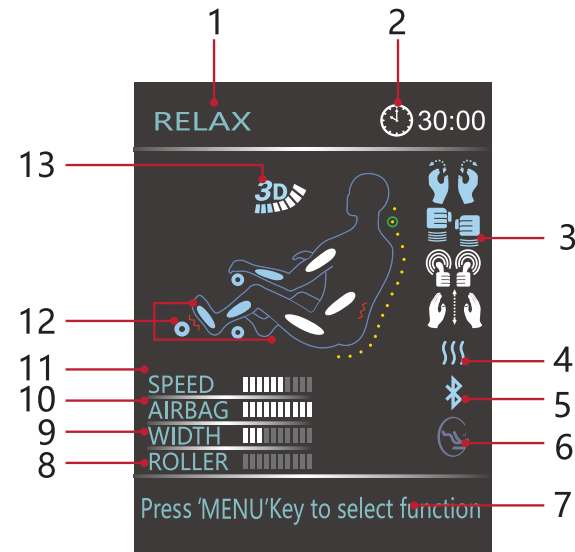

1. Displays which massage program is running.
2. Displays the massage run time.
3. Displays which massage technique is being used.
4. Indicates if the heat function is on.
5. Indicates if the Bluetooth function is on.
6. Indicates if the zero gravity function is on.
7. Displays the controller operation.
8. Displays the massage roller intensity level.
9. Displays the massage roller width.
10. Displays the airbag intensity level.
11. Displays the massage roller speed level.
12. Displays the roller position.
13. Displays the 3D massage intensity level of the current program.

# Operation Guide

## I. Setting Functions Description

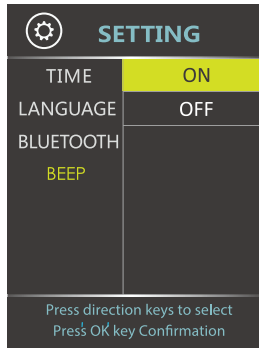
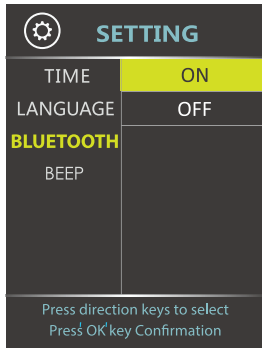
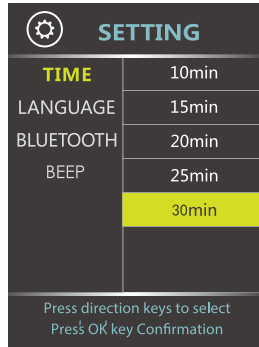
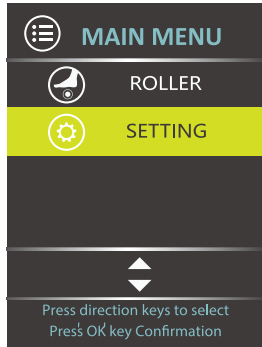

- Select your desired massage time. Press OK button to confirm.
- Select your desired language. Press OK button to confirm.
- Select your desired remote control beep setting. Press OK button to confirm.  
*Note: the beep function toggles ON/OFF the button press sound on your remote control.*
- Select your desired Bluetooth setting. Press OK button to confirm.  
*Note: In order to play music from your Bluetooth enabled audio device, Bluetooth must first be turned on in settings.*

# Product Components

## Main Body Diagram (Front)

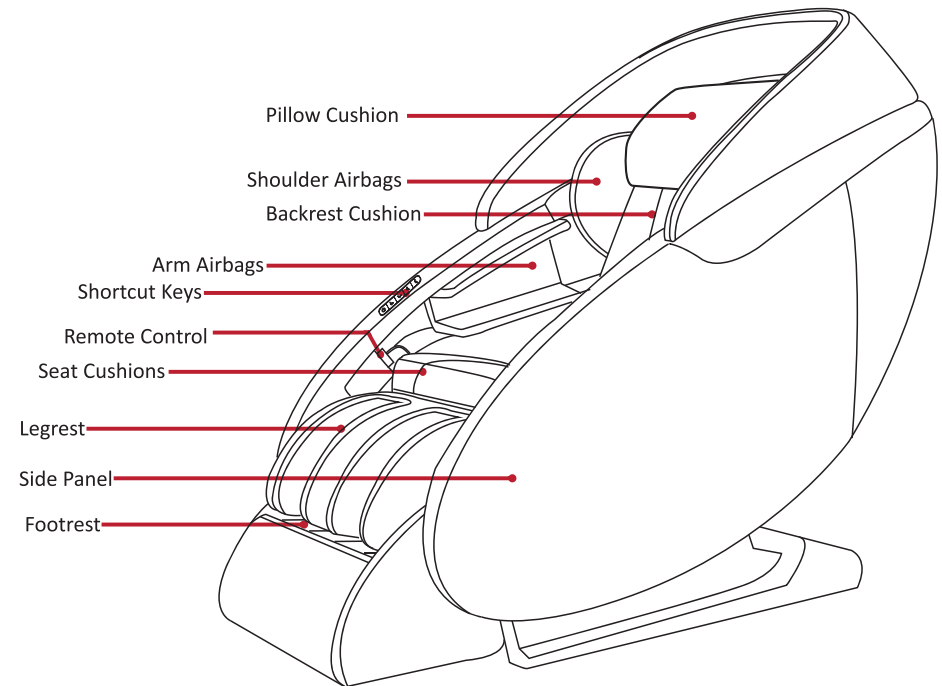

## Main Body Diagram (Rear)

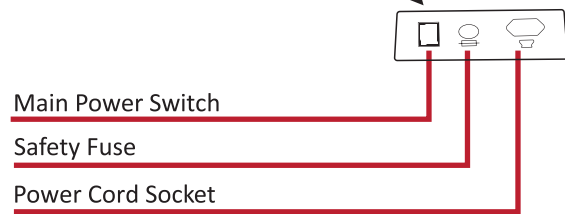
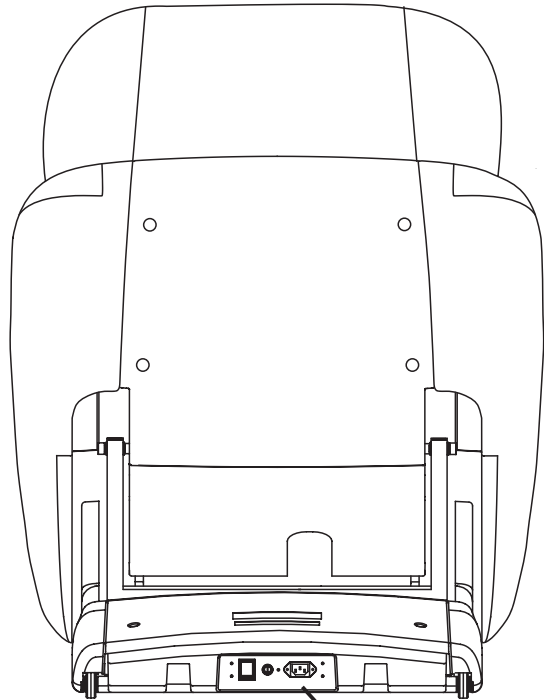

## F. Airbag Adjustment

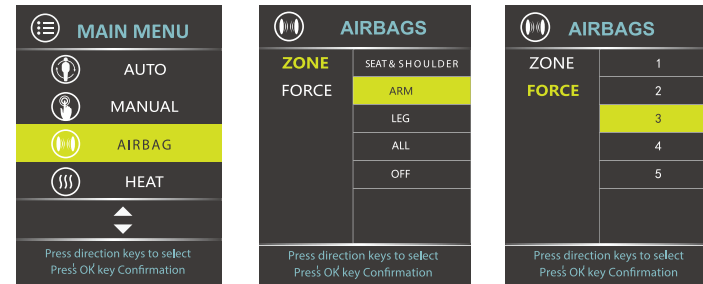

- Airbag Part: Press the direction key to select which airbag regions you would like turned on or off. Press OK button to confirm.
- Airbag Force: Choose from airbag intensity levels 1 through 5. Level 3 is the default intensity setting. Press OK button to confirm.

## G. Heating Function

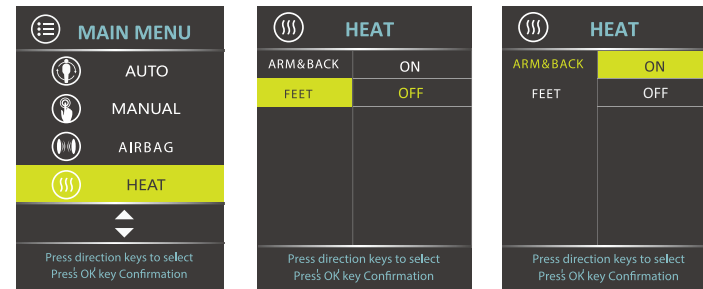

- Select desired area to heat, then select ON.

## H. Adjustment of Roller Massage Function

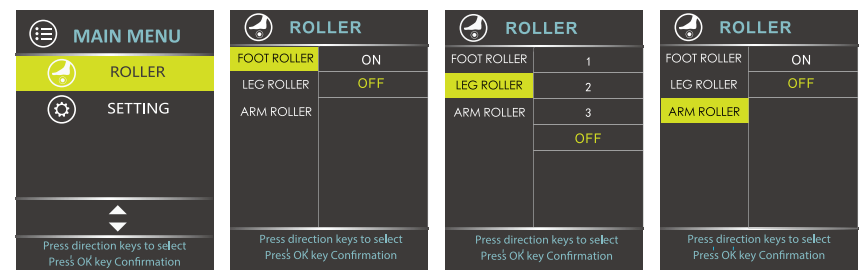

- Select foot roller function and choose ON or OFF. Press OK button to confirm.
- Select leg roller function. Choose from levels 1-3, or OFF. Press OK button to confirm.
- Select arm roller function and choose ON or OFF. Press OK button to confirm.

# Operation Guide

D. Select your desired manual mode and press the OK button to confirm.

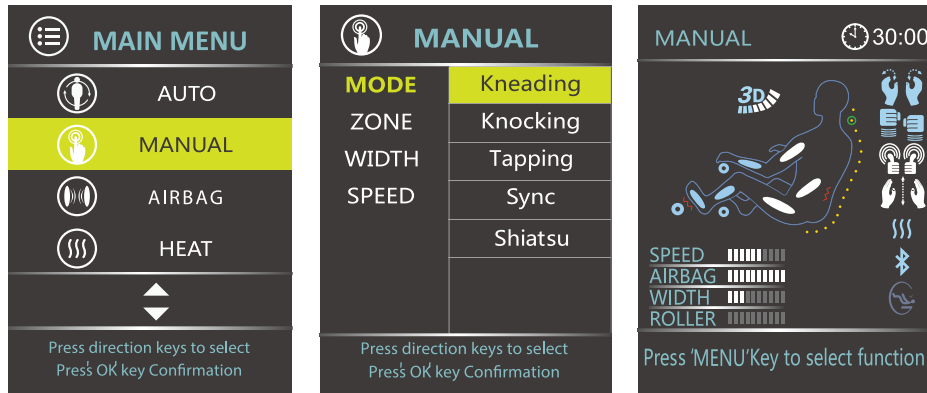

- Choose from 5 massage techniques when in manual mode: Kneading, Knocking, Tapping, Sync, and Shiatsu

E. Customize your massage.

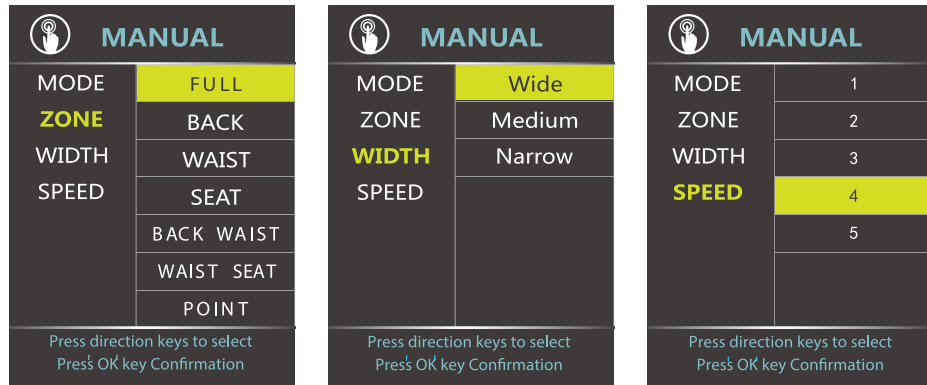

- Massage Zone: Choose from Full, Back, Waist, Seat, Back Waist, Waist Seat, and Point.
- Width Adjustment: Use direction buttons to select your desired width. (Available in Knocking, Tapping, and Shiatsu modes)
- Speed Adjustment: Use direction buttons to select your desired speed from 5 levels. (Available in Kneading, Knocking, Tapping, Sync, Shiatsu.)

# Chair Installation

5. Moving the Massage Chair

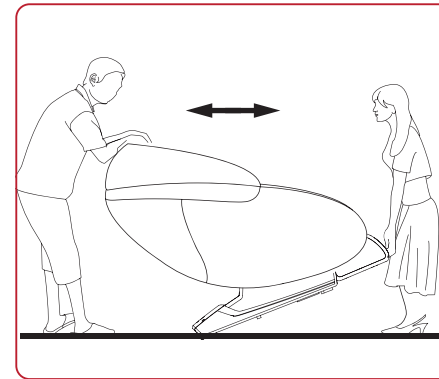

As illustrated, push the backrest downwards and tilt the chair onto its wheels at a 45° angle. Slowly push and maneuver the massage chair to the desired location. Lower the chair slowly and smoothly until it is fully flat on the ground.

- Do not move the massage chair when occupied or in use.
- Moving the massage chair may cause damage to floors. Floor protection is recommended (e.g.: rugs, carpets).
- Do not drop or suddenly let go of the chair when moving, as it may damage the chair and the floor.
- Two person participation is recommended for moving the massage chair. Please use caution when handling the chair.

6. Place the massage chair in an open area.

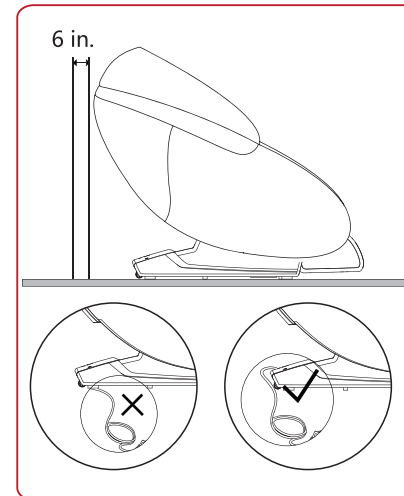

- Allow sufficient space around the chair for reclining purposes. There should be 6 in. on the back side and 20 in. in front of the footrest.
- In order to avoid the damage to the floor and reduce noise, place an area rug under the massage chair.
- Ensure there are no objects in front of or behind the massage chair.
- Do not place the chair on a wet or uneven floor.
- To avoid signal interference, place the chair 4 feet away from AV, TV, and radio.



## Before Use

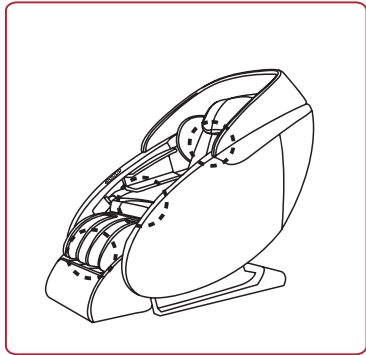

1. **Make sure the product is in good condition and proper working order.**
  - Check the headrest and backrest pad.
  - Inspect the power plug.
  - Make sure the footrest is in its upright original position in order to prevent damage.

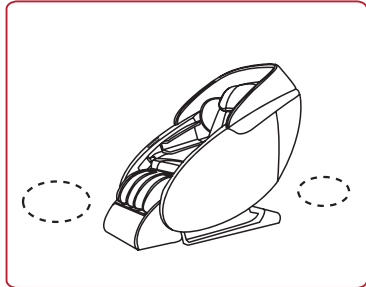

2. **Check the surrounding environment**
  - Ensure there are no people, pets, or objects obstructing the massage chair.

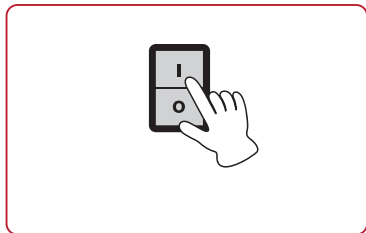

3. **Plug in the massage chair power cord.**
  - Connect the power cord.
  - Turn ON the power switch, located on the right side of the massage chair.

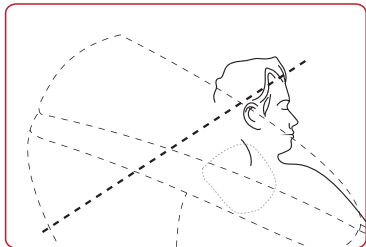

4. **Adjust the position of the headrest.**
  - Adjust the headrest until it is in a comfortable position.

## Operation Guide

### B. Select your desired auto mode.

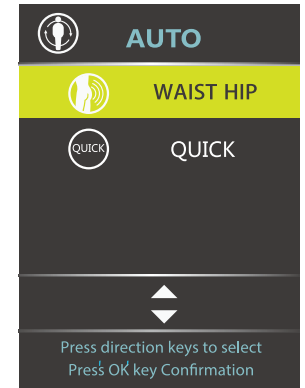
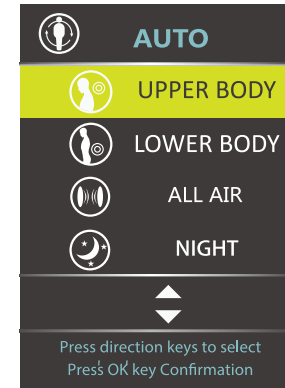

- Your massage chair features 9 automatic massage programs, and one 5-minute quick demonstration automatic program.
- The automatic programs include: Relax, Renew, Recovery, Stretch, Upper Body, Lower Body, All Air, Night, Waist Hip, and Quick.

### C. Press OK button to confirm your selected auto program.

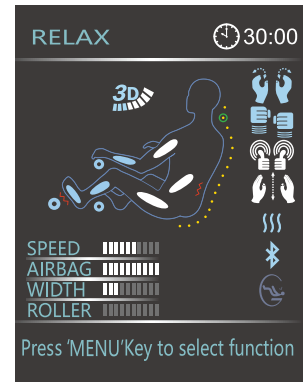
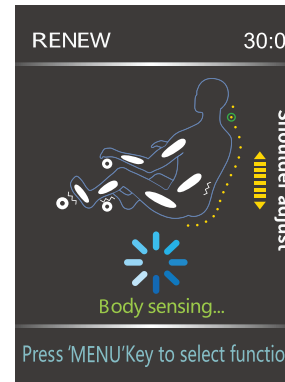
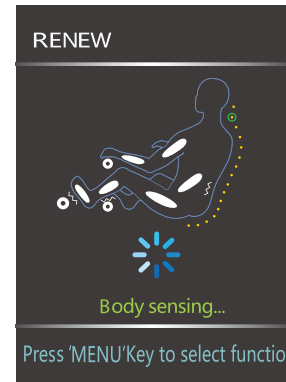

- When you first begin an auto program, the shoulder scan will begin.
- You can adjust the shoulder position within 8 seconds of the shoulder scan completing.
- When you select other modes during a single massage session, the chair will remember your shoulder position.

# Operation Guide

 Use these keys to adjust the massage rollers up and down.

 Press this button to return to the main menu.

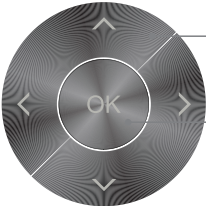
 Use these keys to navigate Up, Down, Left, and Right.  
Press this button to confirm the selection.

## 4. Massage Programs and Selections

### A. Switch on the chair.

- On the controller screen display menu, select your desired program and enter the second menu.

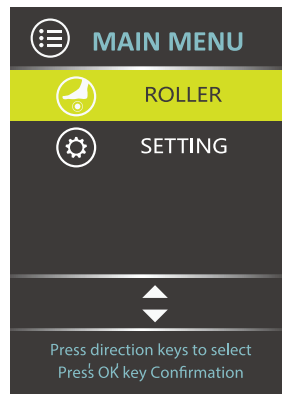
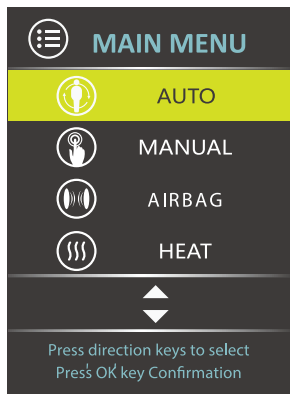

- Main Menu options are: Auto, Manual, Airbag, Heat, Roller, and Setting.

# Operation Guide

## 1. Remote Controller

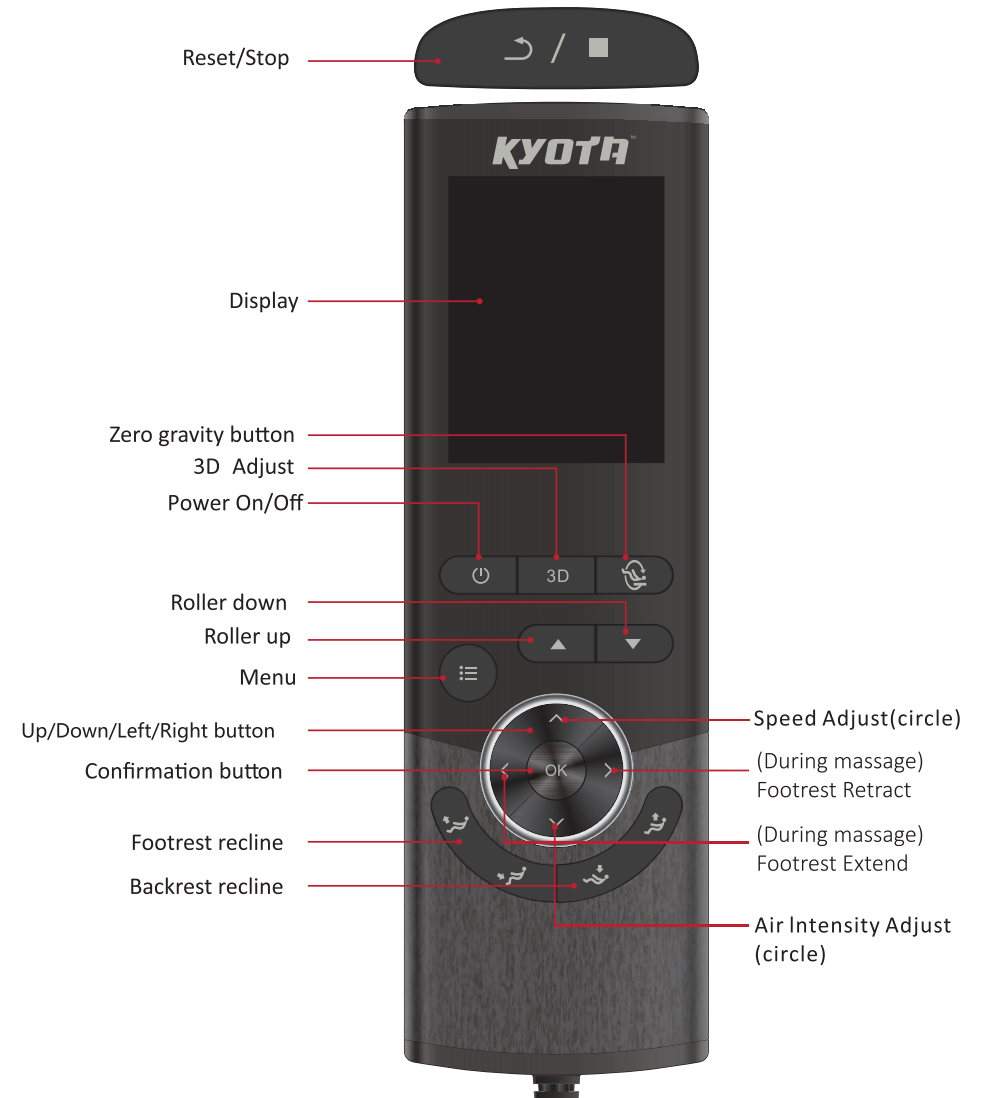

## Operation Guide

### 2. Shortcut Key Functions (Right Armrest)

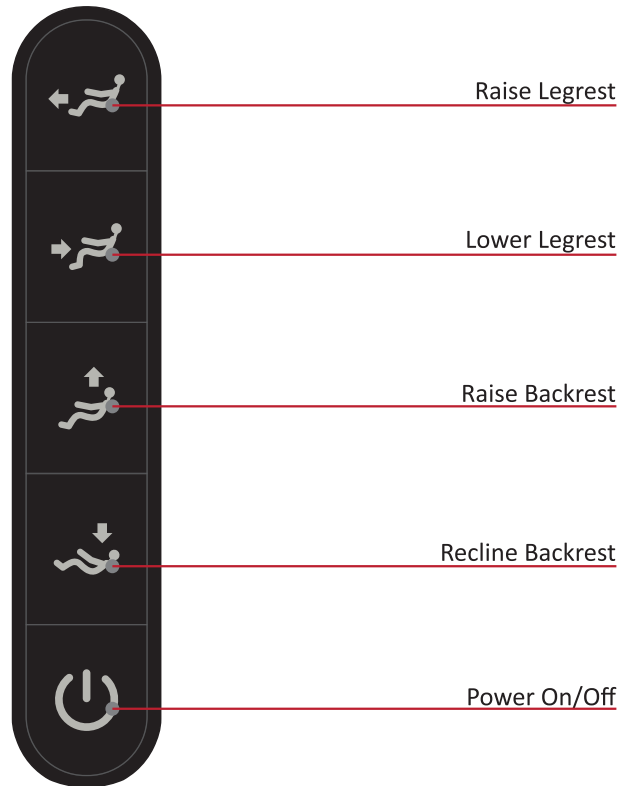

## Operation Guide

### 3. Remote Button Functions



**Reset / Stop:**  
Press to temporarily pause the massage, the chair will go into "idle" mode. Press again to resume the massage cycle.



Press once to power on the massage chair, press again to power off.

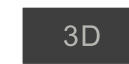

The 3D button on the controller allows you to adjust the depth of the massage node rotation, from Level 1 (lightest) to Level 8 (deepest).

#### Massage Chair Position Adjustment:



**Zero Gravity function button:**  
Zero Gravity Position1 → Zero Gravity Position2  
→ Zero Gravity Position3 → Zero position off

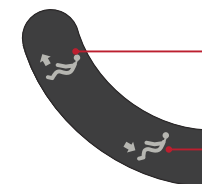

Press and hold this button to raise the footrest to the desired position.



Press and hold this button to lower the footrest to the desired position.

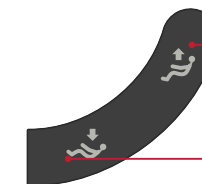

Press and hold this button to raise the backrest to the desired position.



Press and hold this button to recline the backrest to the desired position.

**Please Note: The position adjustment buttons do not function during operation of the Stretch program.**