

INFINITY[®]

MASSAGE CHAIR



INFINITY[®]

72 Start Road, Seabrook, NH 03874
603-910-5000
www.infinitymassagechairs.com

User Manual

SMART CHAIR X3

▶ TECHNICAL SPECIFICATIONS

Name: Infinity Deluxe Massage Chair

Model: SMART CHAIR-X3

Rated voltage: 110V~

Rated frequency: 60 Hz

Rated power: 120W

Safety design: Class I

Thank you for your purchase of this product. Before using, please read this USER MANUAL carefully, and pay special attention to the safety information to ensure handy operation and use.

Please keep this USER MANUAL properly for future reference.





▶ CONTENTS

SAFETY PRECAUTIONS	1
NAME AND FUNCTION OF EACH COMPONENT	3
External structure	3
Internal structure	3
Power box	4
Controller	5
Controller buttons	6
FUNCTIONS AND FEATURES	13
APP DOWNLOAD AND INSTALLATION	14
PREPARATION BEFORE USING	16
Installation position	16
Floor protection	16
Surrounding environment	17
Grounding	17
Installation method	18
Proper method for moving the chair	23
Turn on power supply	23
First use of massage chair	24
Before sitting in the chair	24
PRODUCT STORAGE AND MAINTENANCE	25
TROUBLE SHOOTING	26
TECHNICAL SPECIFICATIONS	27



▶ SAFETY PRECAUTIONS

Safety Precautions

- ▶ Before using, please read SAFETY PRECAUTIONS carefully to ensure proper operation.
- ▶ The following SAFETY PRECAUTIONS will help you operate this massage chair correctly.
- ▶ To clearly indicate the degree of danger and damage, the type of accidents caused by incorrect use are classified into “WARNING” and “CAUTION.”
Instructions marked as follows should be strictly adhered to:

 WARNING	Improper operation may cause injury to user.
 CAUTION	Improper operation may cause user injury or product damage.
	Forbidden. Specific instruction will be indicated in the diagram drawings.(E.g, the left drawings means disassembly is not allowed.)
	Compulsory. Specific instruction will be indicated in the diagram drawings.(e.g, the left drawings means to disconnect the power plug)

WARNING

 COMPULSARY	<p>We recommend that those with any of the following conditions should consult a doctor before using:</p> <ol style="list-style-type: none"> 1. Those with an electronic medical instrument imbedded in the body, such as a cardiac pacemaker. 2. Those being treated by doctors, especially those experiencing pain. 3. Those suffering from cancer, heart disease or other serious illnesses. 4. Women who are pregnant. 5. Those with osteoporosis or spinal injuries. 6. Those with skin diseases or open wounds . 7. Those whose body temperature is over 100 degrees Fahrenheit.
 PROHIBITED	<p>Do not allow disabled persons to use the chair unattended. (Supervised use is OK).</p> <p>Do not allow children play on massage chair.</p> <p>Do not allow more than one person to use this massage chair at a time.</p> <p>If the power cord or power plug becomes damaged in any way, turn the chair OFF and disconnect the plug from the wall socket immediately. Consult an authorized service engineer for repair or replacement.</p> <p>Do not damage, excessively bend, pull twist or knot the power cord.</p> <p>Children are not allowed to use this product.</p>
 NO DISASSEMBLY	Anyone else, except maintenance personnel specified by our company, should not disassemble, maintain, or remodel this massage chair. If you experience any problems, please contact a local dealer immediately.

▶ TROUBLE SHOOTING

No.	Problem	Possible Cause	Solution
1	You hear a rubbing or a knocking sound.	This is a normal sound made by the motor or produced when the massage ball is rubbed against the cloth cover.	It is normal. There is no need for treatment.
2	The machine can not start up.	The power plug is detached from the wall socket.	Insert the power plug into the socket again.
		The power switch is not turned on.	Turn on the switch.
3	The airbag installed in the seat cushion or legrest does not work.	The fuse of massage chair blew out.	Replace the fuse with a new one of the same model.
		Check whether there is a blockage in the air tube.	Clear the air tube

If the chair still does not operate normally after the above measures have been taken, please contact a local distributor for repair and maintenance.

Note: Do not dismantle the product by yourself. Our company shall shoulder no responsibility for the damage to the product or injury of people caused by improper use! Thanks for your cooperation.

▶ PRODUCT STORAGE AND MAINTENANCE

Maintenance

- ▶ Use a damp cotton cloth with mild soap to wipe the back cover, hand rest, legrest, air tube and other plastic components. Then wipe with a dry cotton cloth.
- ▶ Use a dry cloth to wipe the controller and power supply box.
- ▶ Use a damp cotton cloth with mild soap to wipe the back cushion and pillow, wipe again with a different damp cloth. Put them to a well-ventilated place to dry.

Caution

- ▶ Make sure to unplug before beginning maintenance. To avoid electric shock, do not use wet hands to pull out the plug. When cleaning the back cover, please do not allow soap or water to enter into the power supply box!
- ▶ Do not iron the upholstery.

Storage method

- ▶ Wipe off dust and dirt from the product after use. If the product is not to be used for a long period of time, please cover the product with a dust cover (self provided).

Caution

- ▶ Do not store the product in direct sunlight or in places of high temperature. This may cause the color of the upholstery to fade.

Reminder

During daily use, please check for the following issues:



- ▶ A scorched or burning odor
- ▶ Power flickering on and off if power cord is touched
- ▶ Extremely hot power cord
- ▶ Other abnormal indicators

Caution

- ▶ To avoid breakdowns and accidents, please stop using the massage chair if any above warning signs occur.
- ▶ Turn off the power switch and pull out the power plug. Contact the local distributor or headquarters for repair and maintenance.
- ▶ All repairs and maintenance can only be performed by our authorized dealers or service agents, except for the normal operation and maintenance detailed above.

▶ SAFETY PRECAUTIONS

CAUTION

 COMPULSARY	<ul style="list-style-type: none"> ◆ Please do not continuously use the massage chair for more than 20 minutes. Limit massage to a particular part of body to 5 minutes. ◆ Please put the massage chair on flat ground during use. ◆ When adjusting the legrest or backrest, please do not exert excessive force on it. Keep children and pets well clear. ◆ When removing the power plug, please hold the insulated plug. Do not pull the power cord. ◆ Please do not use a power source that is beyond the specified electric voltage, as this may cause fire or damage massage chair. ◆ Before using, please uncover the back cushion to check whether the backrest or fabric is damaged. If damaged, please stop using this massage chair immediately, and contact the local distributor for repair. ◆ Please do not operate the controller with damp hands, and do not put heavy objects on the controller. ◆ The maximum weight capacity for the massage chair is 250 pounds. ◆ Please do not use other therapeutic equipment while using this massage chair. ◆ If you feel uncomfortable, please stop using the chair immediately and consult your doctor. ◆ This massage chair is designed and intended for non commercial household use only. Do not use the massage chair for medical treatment. ◆ The massage chair is equipped with a heating function. Please use with caution . ◆ Always switch off power and remove the plug from the wall socket immediately after use and before cleaning.
 PROHIBITED	<ul style="list-style-type: none"> ◆ To avoid causing discomfort, do not use the massage chair immediately after meals. ◆ Do not fall asleep in the massage chair while it is operating. ◆ Do not use the massage chair if you are intoxicated or ill. ◆ If the upholstery becomes dirty, use only good quality leather cleaner. Do not use chemical cleaners, petrol or detergents. ◆ To avoid accidental injury or machine damage, do not sit on backrest, legrest or armrest. ◆ Please do not smoke while using the massage chair.
 REMOVE PLUG	<ul style="list-style-type: none"> ◆ Before performing maintenance, please remove the power plug. To avoid electric shock, please do not insert or pull out the plug with damp hands. ◆ When the massage chair is not in use, please switch off power and remove the plug from the wall socket.

▶ NAME AND FUNCTION OF EACH COMPONENT

Exterior structure

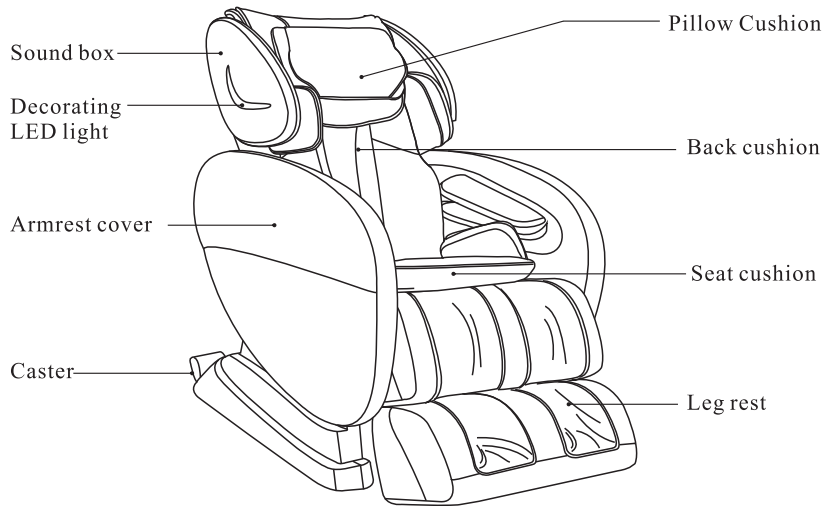

Interior structure

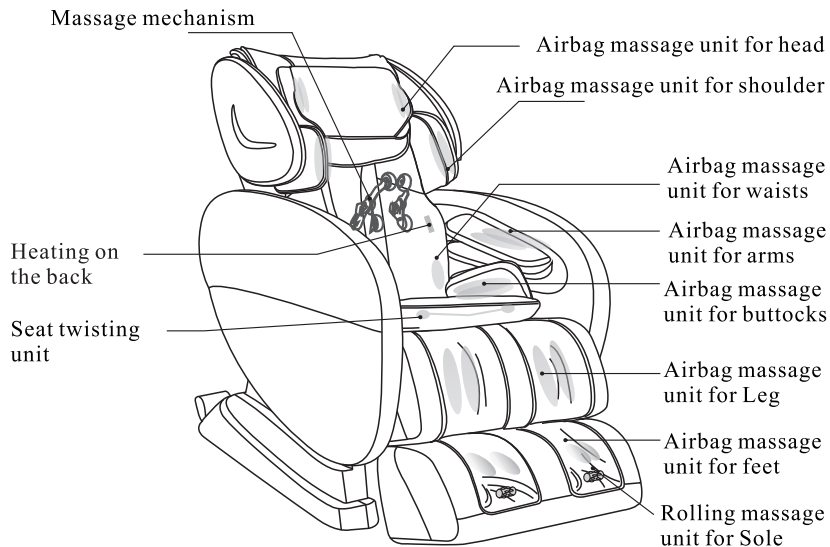

▶ PREPARATION BEFORE USING

First use of massage chair

- ▶ Before first use, please make sure there is enough space around the chair. Use the controller to recline the backrest to the lowest position, raise the legrest to the highest position and stretch out the chair to its maximum length.
- ▶ Test that all functions work normally, then power off the chair. Return back to original position.
(To select the program, please refer to "Controller instruction" and "Display screen menu instruction.")

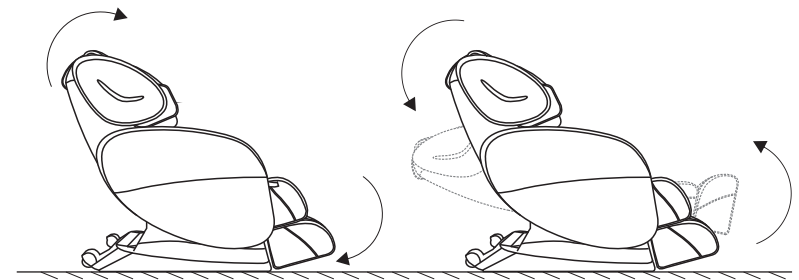

⚠ Caution

- ▶ Do not put fingers or any other objects into the gap between the seat and legrest.
- ▶ When adjusting up and down angles of the backrest and legrest, please make sure there is no obstacle around the massage chair.
- ▶ During use, please make sure the power cord is not tangled, twisted or bent.

Before sitting in the chair

- ▶ Make sure the legrest is working properly.
- ▶ Make sure the chair is in the original, upright position. If any part is not in the original position, please power on/off again to make the chair go

⚠ Caution

- ▶ Do not climb into the chair if the legrest is raised. Return the legrest to the closed position, sit down in the chair, then raise the legrest while seated in the chair.
- ▶ Do not sit on, or put heavy objects on the legrest. This may damage the legrest mechanism.

▶ PREPARATION BEFORE USING

Proper method for moving the chair

- ▶ There are moving rollers at the bottom of the chair.
- ▶ To move, return the chair to upright, original position.
- ▶ Switch off and unplug the chair.
- ▶ Lift the front part of the chair as shown in the figure (one person raise the front part via the moving holder, another person push the chair while holding the top of the chair.) Move the chair on the rollers.

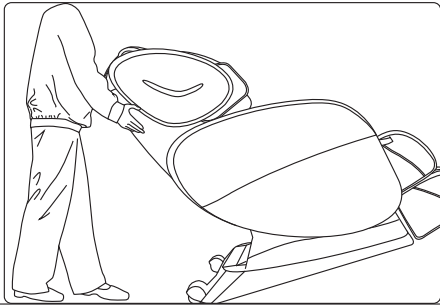

⚠ Caution

- ▶ Don't move the chair when it is occupied.
- ▶ Don't use the armrest to move the chair. Use the front and back of chair to move.

Turn on power supply

- ▶ Plug the power cord into grounded three-pronged socket.
- ▶ Turn on the power switch on the bottom of massage chair.

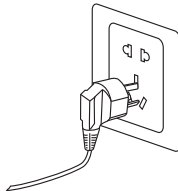

⚠ Caution

- ▶ Before switching on the chair, please make sure there is no damage to the power cord or other exposed wires.
- ▶ Make sure the power switch is off before the chair is connected to the wall socket.

▶ NAME AND FUNCTION OF EACH COMPONENT

Power box

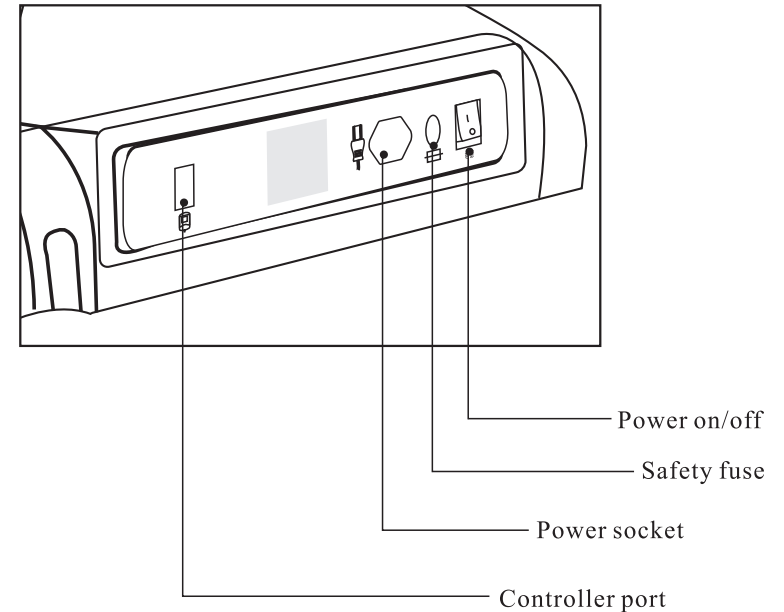

⚠ Caution

- ▶ To avoid accidents involving the power supply box, do not let children play on the chair.
- ▶ Please power off and unplug the chair from the wallsocket after the massage finishes.
- ▶ Do not use the chair during thunderstorms or severe weather.
- ▶ Please power off and unplug the chair from the wallsocket when the chair is not in use, so that children won't accidentally turn on the chair.
- ▶ Please store the chair if it is not in use for a long time.

▶ NAME AND FUNCTION OF EACH COMPONENT

Controller

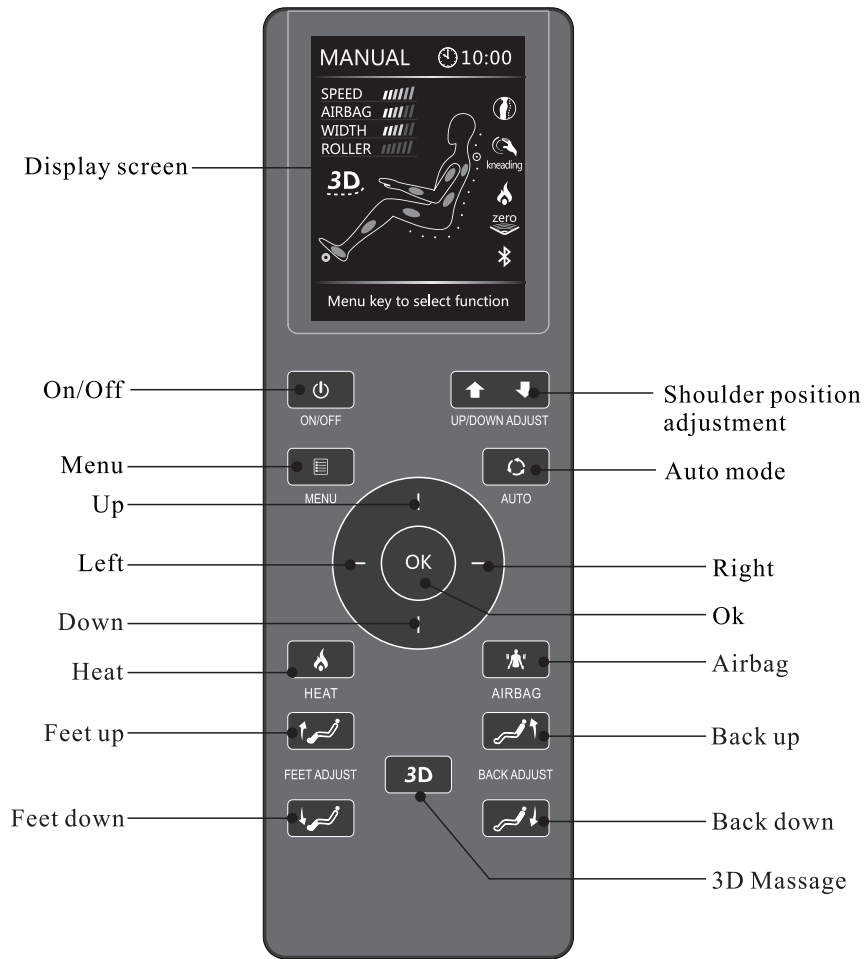

▶ PREPARATION BEFORE USING

Step 6 Other accessories

- ▶ Connect the controller, wire to respective jack on the power supply box.
- ▶ Connect the power and switch on the chair, use the controller to return the backrest to normal position.

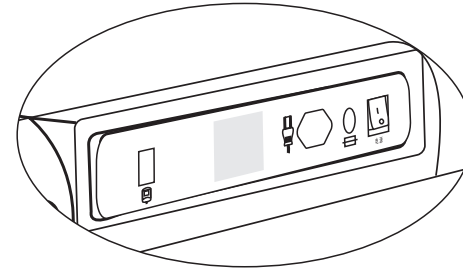

PREPARATION BEFORE USING

Step 4: Installation of the shoulder massager and speaker

- ▶ Connect the wire from the upper side of the backrest with the wire from the speaker.
- ▶ Insert the three joint pins in shoulder massager and speaker into the three connecting tubes in the backrest. (After connected, move the slider down to expose the locking screw.) Fasten them with the locking screws, and move the slider back. (Repeat the same installation method for the other side.)

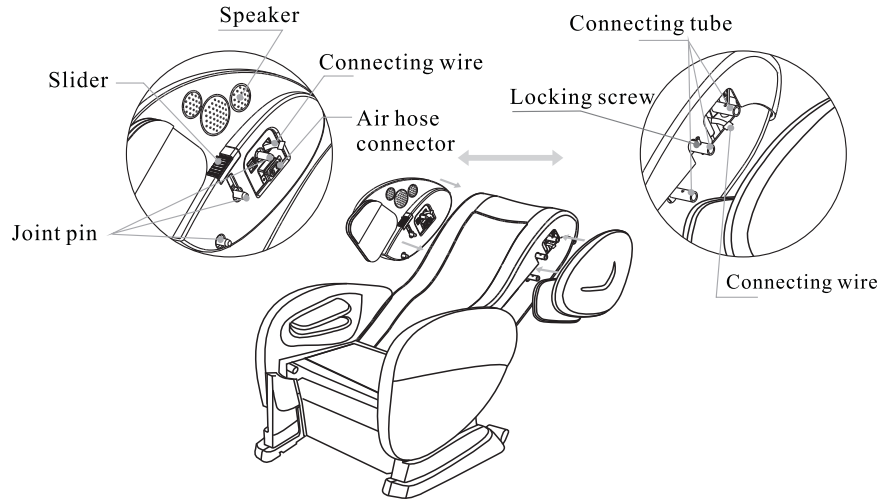

Step 5: Installation of back cushion and buffering cushion

- ▶ Fix the buffering cushion and back cushion on the backrest with zipper. Install the heater accessory on the back cushion. Connect the pillow and waist air tube connector as the illustration shows. Connect the lower part of the cushion with seat cushion by linking tape.

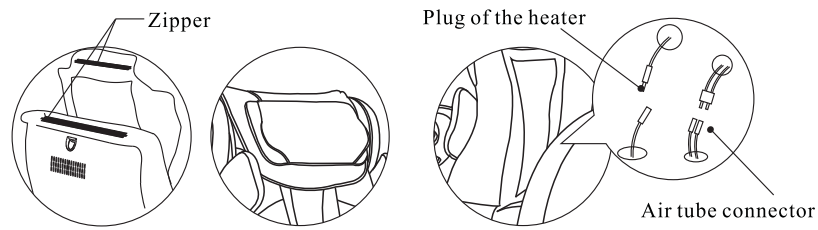





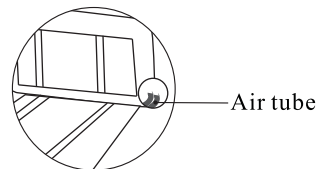



Step 6 Installation of seat cushion

- ▶ Place the seat cushion on the seat shelf, and fix the air tube.
- ▶ Connect cloth on the seat cushion with the linking tape.

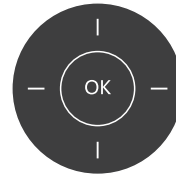

NAME AND FUNCTION OF EACH COMPONENT

Instruction of Controller

-  **On/Off**
 - ▶ When chair power is turned on, click this button to turn on the controls. Click the up/down button to choose auto mode, manual mode, air pressure massage, heat, 3D massage, or to set menu.
 - ▶ Click this button again to turn off all functions. The default
-  **Menu**
 - ▶ Click this button to choose auto mode, manual mode, air pressure massage, heat, 3D massage, and set menu.
-  **Shoulder position adjustment**
 - ▶ Under manual and point mode, press up/down to adjust the position of point massage.
-  **Auto programs**
 - ▶ When the massage chair is working, press the auto button to enter the auto program menu. You can choose sports refresh, extension, rest& sleep, working relief, neck & shoulder or waist & spine according to your own body state and massage time.(3D massage excluded.) (See the LCD menu for detail.)
-  **Direction adjustment**
 - ▶ Under menu and auto mode, press the button to adjust direction. When program is chosen, press the OK button to confirm and enjoy the chosen massage.
 - ▶ During the massage, press the OK button to switch over to zero gravity. Press up or down button to adjust
-  **3D massage**
 - ▶ Under manual mode, press the 3D button to adjust 3D force.
-  **Heating**
 - ▶ Press this button to start the heating function. The indicator screen will light up. Press this button again to turn on the heating function. The indicator will turn off.
-  **Airbag**
 - ▶ Press this button to enter the program for air pressure massage. Press up and down buttons to adjust massage location and air pressure strength.

▶ NAME AND FUNCTION OF EACH COMPONENT



Feet up
▶ Hold this button to raise the legrest. Release this button to stop raising the legrest.



Feet down
▶ Hold this button to lower the legrest. Release the button to stop lowering the legrest.



Back up
▶ Hold to return to the upright position. Release the button to stop.



Back down
▶ Hold this button to lower the backrest. Release this button to stop lowering the backrest.

Instruction for display screen menu

▶ Auto mode

When the chair power is on, press the power button on the controller to turn the LCD on. Press auto to enter the auto program menu. You can choose Sports Refresh, Extension, Rest & Sleep, Working Relief, Neck & Shoulder or Waist & Spine according to your own body state and massage time. (See the menu pictures below.)

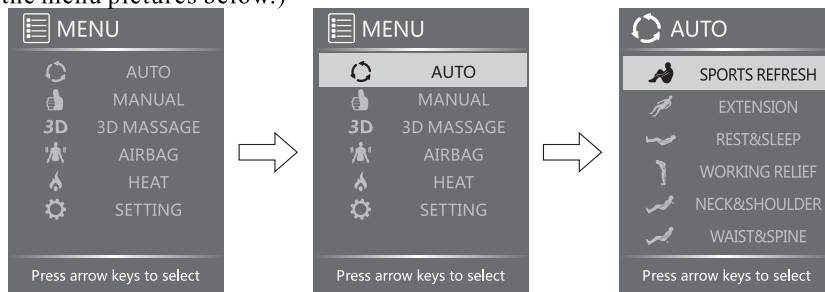

Sports Refresh: This is designed to soothe muscles after a workout. This massage eases and relaxes muscles after intense exercise and promotes circulation to improve muscle recovery.

Extension: This is a Thai massage that includes strong kneading and stretching of the body. It effectively stretches legs, waist and other parts and it is the best choice to relax tired muscles and increase flexibility.

Rest & Sleep: This massage will improve the quality of sleep and relaxation. The mild massage kneads body parts from heavy strength to light, then from light strength to nothing. This relieves a tired body gradually.

Working Relief: This is an exclusive program for those who work long hours at a desk or in an office. It eases muscles and helps the body recuperate.

Neck & Shoulder: This massage relieves neck and shoulder pain and tension. 80% of the massage time focuses on the neck and shoulders. The curved design of the chair backrest helps the massage rollers target the shoulders and neck, so it can effectively relieve fatigue.

▶ PREPARATION BEFORE USING

Step 3: Installation of leg massage shelf

- ▶ Insert the leg connection wire plug to its jack.
- ▶ Connect air tube from the leg massage shelf with its port on the seat shelf.
- ▶ Aim the coupling shaft port on the leg massage shelf to the coupling shaft on the seat and fasten them with one screw on each side.
- ▶ Paste the folding PU cover on the leg massage shelf with linking tape on the cloth of the seat.

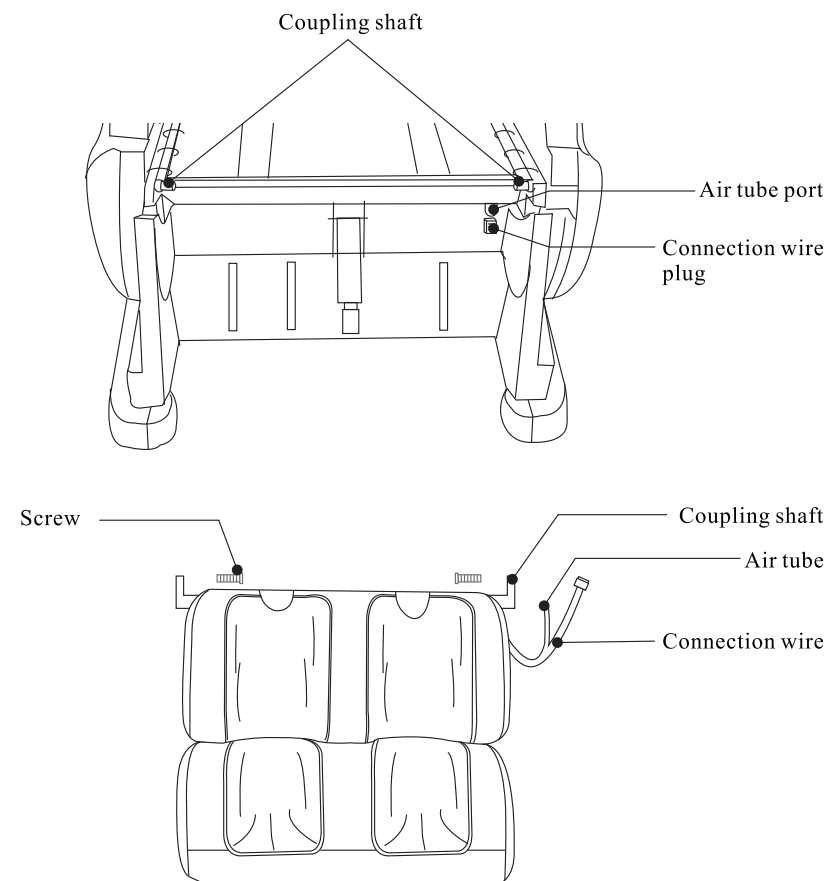

PREPARATION BEFORE USING

- ▶ The connection of the armrest locks with the backrest.
Hold up the rear part of the armrest, push inward to let the gap of armrest lock aim at armrest spindle, then push the armrest to fasten them together. (Press downward the handle of the lock to unlock armrest and backrest.)

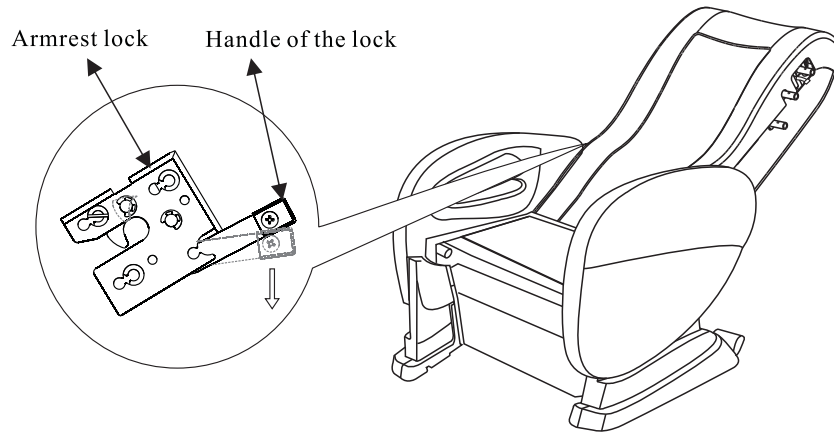

NAME AND FUNCTION OF EACH COMPONENT

Waist and Spine: Relieves pain of the lumbar area. 80% of the massage time focused on the lumbar region and the rollers target the area to relieve tension.

▶ Manual Programs:

Press MENU button, choose MANUAL and press to enter manual programs. Press the up or down button to choose MODE, PART, WIDTH, SPEED, ROLLER or ZERO.

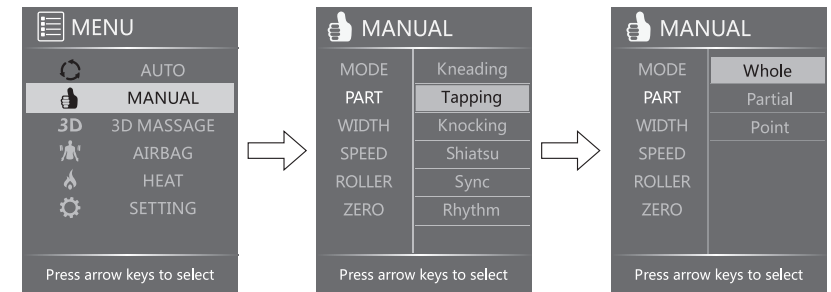

Mode: Under the MODE function, press the right button first, then press the up or down button to choose massage type: Kneading, Tapping, Knocking, Shiatsu, Sync, or Rhythm.

Part: Under the PART function, press the right button first, then press up or down button to circulation choose Whole, Partial or Point. This is for the back massage mechanism.

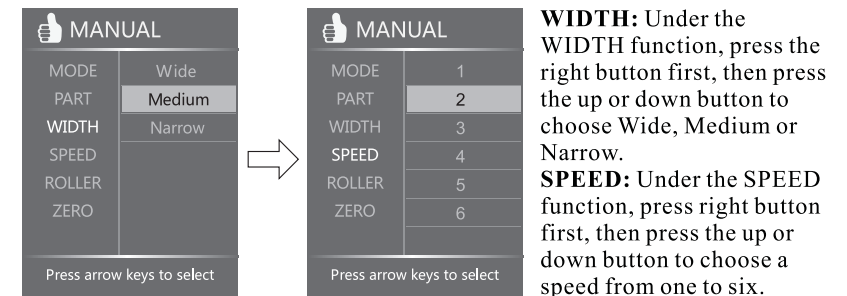

WIDTH: Under the WIDTH function, press the right button first, then press the up or down button to choose Wide, Medium or Narrow.

SPEED: Under the SPEED function, press right button first, then press the up or down button to choose a speed from one to six.

ROLLERS: Press the MENU button first, then choose ROLLER. Adjust the roller speed from 1 to 3 or stop the rollers by pressing the up or down button.
ZERO GRAVITY: ZERO GRAVITY creates a completely relaxing, naturally comfortable massage position: It is designed to raise the back, buttocks and leg stay at a certain angle and relax muscles.

▶ NAME AND FUNCTION OF EACH COMPONENT

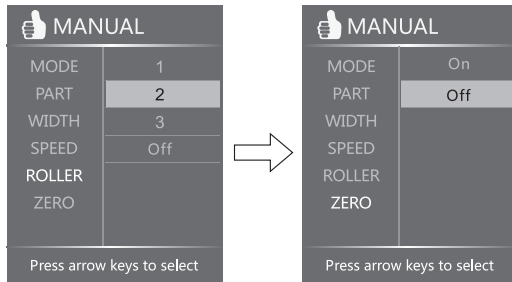

▶ 3D MASSAGE

Press MENU button. Choose 3D. Adjust the 3D MODE (Deep shiatsu, healthy breath, Massage extend), massage FORCE and PART.

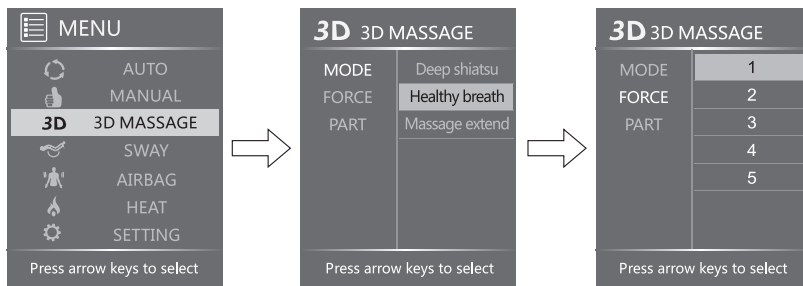

Deep shiatsu: Deep shiatsu massage on the back for 10 minutes.

Healthy breath: Works to support, slow rhythmic breathing for 5 minutes.

Massage extend: Enables user to extend massage for an additional 5 minutes.

FORCE: User can manually adjust 3D massage force from level 1 to 5.

Part: Under PART function, press the right button first, then press the up or down button to choose Whole, Partial or Point massage.

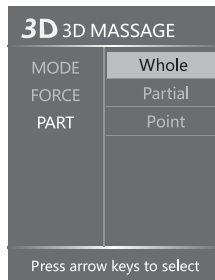

▶ PREPARATION BEFORE USING

Installation method

Step 1: Take out the components of massage chair

- ▶ Open the main carton, and take out the quilting product packages, accessory carton and the main body of the massage chair carefully.
- ▶ Check whether the components are complete. (Please check one by one according

Step 2: Install left and right armrests

- ▶ Connect the air tube port under the armrest to its corresponding output air tube. (It is the same way for the other side.)

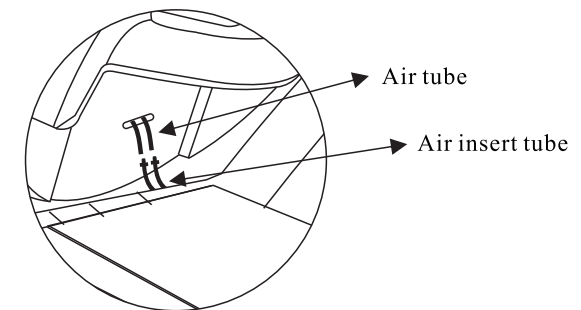

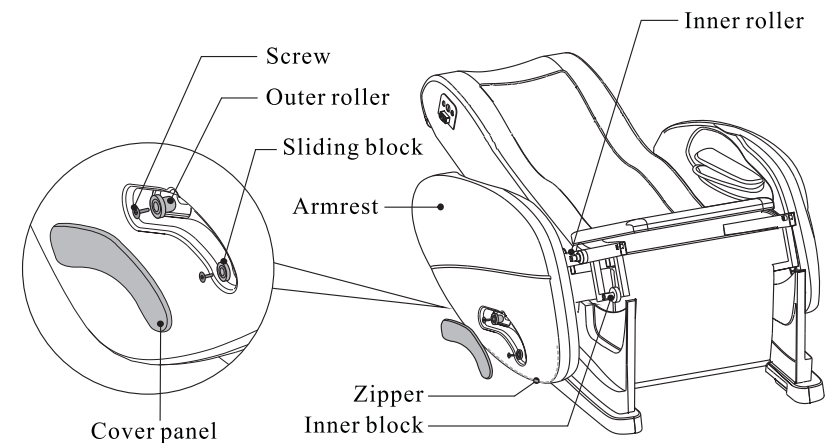

- ▶ Open the zipper of armrest and PU cover, then take cover panel out.
- ▶ Install the armrest with arm shelf, pls assure that the fixing hole aim at the inner roller and blocks of seat shelf, push the armrest forward, then fix with screws, outer roller and sliding blocks. (It is the same way as the othe side), (Note: the sliding blocks rubber side should be outward when fixing the sliding block)



PREPARATION BEFORE USING

Surrounding environment

 Keep the massage chair away from damp places (for example: bathroom) to avoid electric shock.

 Keep the massage chair away from heat sources (for example: stove) to avoid fire or damage to leather material.

Grounding

This massage chair is a Level One electrical appliance, and requires a three-pronged power socket to guarantee the wire connected to the power socket is grounded to avoid electric shock and other negative effect during use.

DANGER Improper connection of the equipment-grounding conductor can result in a risk of electric shock. Check with a qualified electrician or serviceman if you are

in doubt as to whether the product is properly grounded. Do not modify the plug provided with the product if it will not fit the outlet, have a proper outlet installed by a qualified electrician.

This product is for use on a nominal 120-volt circuit and has a grounding plug that looks like the plug illustrated in sketch A in following figure. Make sure that the product is connected to an outlet having the same configuration as the plug. No adapter should be used with this product.

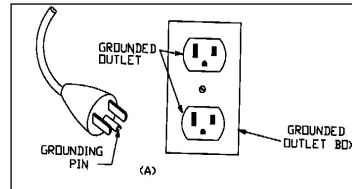

Earthing

► This massage chair belongs to Level One electrical appliance, make sure to use three-core power supply socket and to guarantee the ground wire connected to the power supply socket has obtained good ground connection to avoid electric leakage, electric shock and some other negative effect during use.

NAME AND FUNCTION OF EACH COMPONENT

SWAY :
Press the MENU button first, then choose SWAY. Press the up or down button to choose SWAY/FORCE.

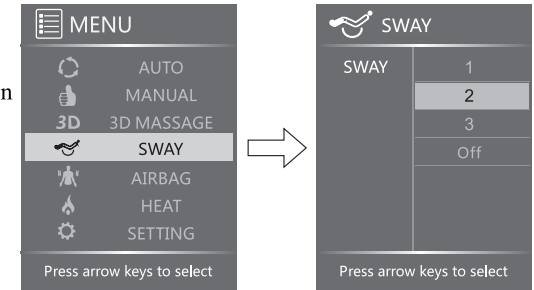

► **AIRBAG :** Press the MENU button first, then choose AIRBAG. Press the up or down button to choose airbag PLACE and FORCE.

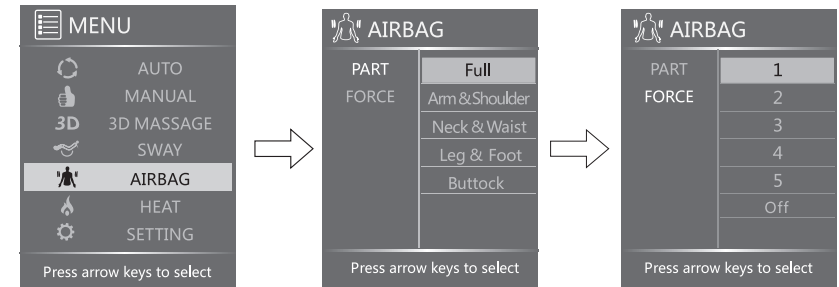

PART: Under the AIRBAG/PART function, press the right button first, then press the up or down button to choose Full, Arm & Shoulder, Back & Waist, Leg & Foot, or Buttock.

FORCE: Under the AIRBAG/FORCE function, press the right button first, then press the up or down button to choose airbag force from 1 to 5 or to stop the airbag.

► **Heat:**
Click MENU, choosing HEAT. Click right to choose On or Off.

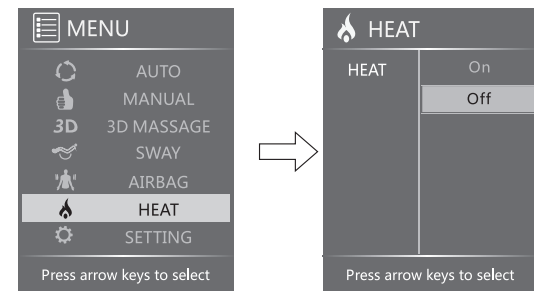

▶ NAME AND FUNCTION OF EACH COMPONENT

- ▶ **SETTING:** Press the MENU button, choose SETTING, then press the up or down button to set TIME, LANGUAGE or BLUETOOTH.

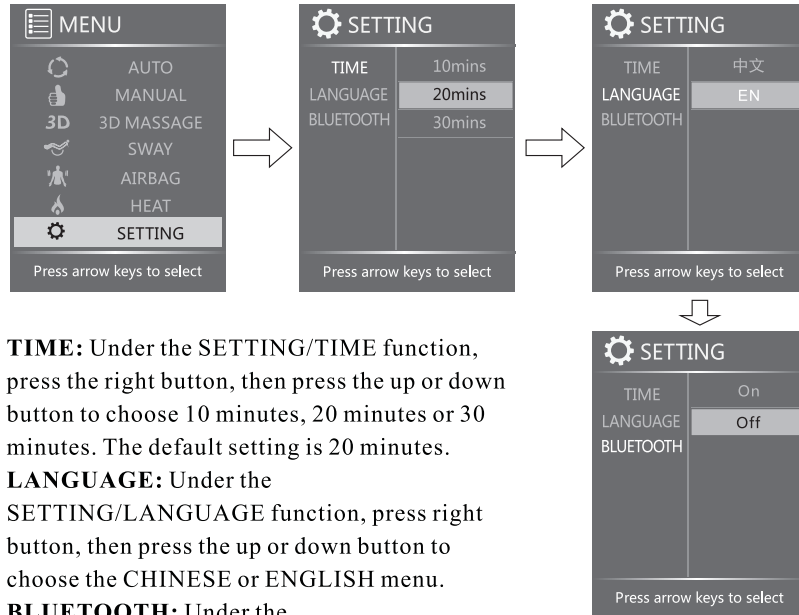

TIME: Under the SETTING/TIME function, press the right button, then press the up or down button to choose 10 minutes, 20 minutes or 30 minutes. The default setting is 20 minutes.

LANGUAGE: Under the SETTING/LANGUAGE function, press right button, then press the up or down button to choose the CHINESE or ENGLISH menu.

BLUETOOTH: Under the SETTING/BLUETOOTH function, press the up or down button to START or STOP Bluetooth.

Reminder: All the above settings are saved even when the machine is turned off suddenly.

▶ PREPARATION BEFORE USING

Installation position

Ensure that there is a safe distance around the periphery of massage chair.

- ▶ Please make sure there is adequate space for installation of this product:
 - Back: minimum 20 inches from the wall or any other obstacles;
 - Front: minimum 16 inches from any obstacles;
- ▶ In order to prevent signal interference, please keep at least 3 feet away from the TV, radio or other video and audio devices.

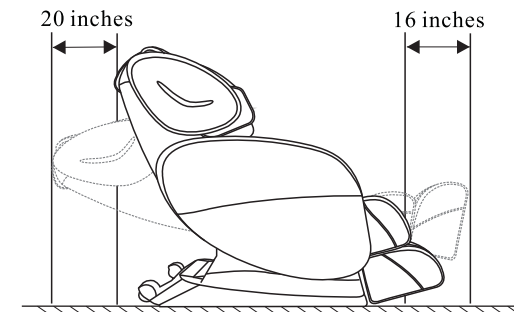

Floor protection

- ▶ In order to prevent damage to the floor, please put carpet or other padding under the massage chair.

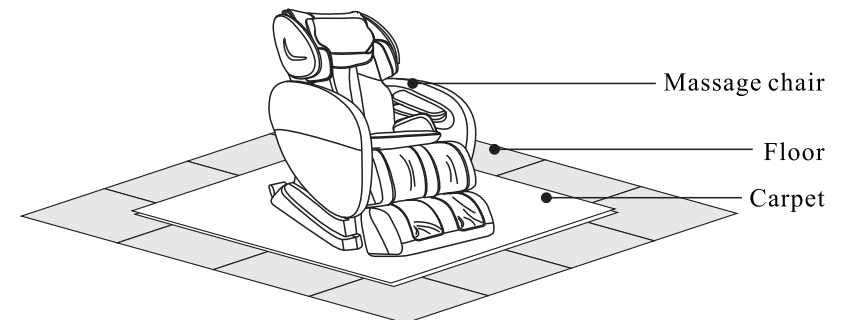

▶ APK DOWNLOAD AND INSTALLATION

Android System

Software

- ▶ Please ask for software from seller, then install on your computer or mobile device. (Refer below pics.)
- ▶ Install the SMART CHAIR-X3 touch screen operation software. Go into the settings menu of the computer or mobile device, choose wireless, and Bluetooth. Your computer or mobile device should find Bluetooth device SMART CHAIR-X3. Click on this to match the massage chair with your device.

⚠ Caution

- ▶ When connecting via Bluetooth, please make sure the chair is powered on, otherwise your device won't be able to find the chair to match with it.
- ▶ If your device is unable to find SMART CHAIR-X3, please try connecting again.
- ▶ Please pay attention to Android System updates to ensure Bluetooth continues to work properly.

Equipment requirements

- ▶ Your computer or mobile device must have Bluetooth connectivity to function.
- ▶ Android System v2.2 or higher is required.

▶ NAME AND FUNCTION OF EACH COMPONENT

Note:

Under AUTO or MANUAL mode, the controller returns to the home page 10 seconds after the chair stops operating.

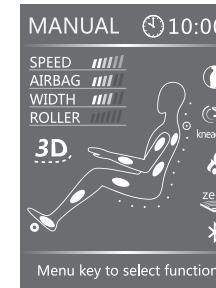

Home page in manual mode

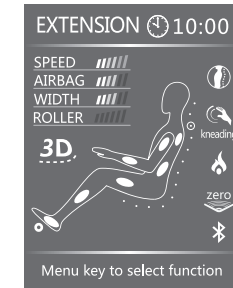

Home page in auto mode

⚠ Caution

- ▶ If you click MENU twice while the chair is operating, the controller will return to the home page immediately.
- ▶ On the home page, under MANUAL or AUTO mode, click the left or right button to adjust air pressure intensity. In MANUAL mode, click up and down to adjust massage wheels speed.
- ▶ Click AUTO to choose auto program directly.

⚠ Caution

- ▶ Please do not dismantle the product.
- ▶ Please do not splash water and other liquids onto the controller.
- ▶ Please do not put heavy items on the controller or power cable.

► FUNCTIONS AND FEATURES

1. Bluetooth audio features

This product includes Bluetooth connectivity. It can play music via other Bluetooth-enabled devices including Android phones or tablets, or Apple iOS compatible devices, such as iPhones or iPads.

2. Zero Gravity

This chair uses zero gravity technologies from NASA. The chair can angle the legs higher than the heart, imitating weightlessness of space, fully releasing the weight of the body, and relieving stress.

3. 3D massage mechanism

The innovative 3D massage mechanism and traveling structure perfectly match ergonomic human engineering.

4. Six levels of massage intensity

This massage chair includes 6 levels of massage intensity. Via MANUAL mode, you can select the massage intensity according to your needs.

5. Air pressure massage

This chair provides air pressure massage for back, waist, shoulder, arm, buttock, calf, and feet.

6. Diversified massage modes

Diversified massage modes: Knocking, Kneading/Knocking, Kneading, Shiatsu, imitating the skills of a professional masseuse.

7. S shape massage track

8. Swing function

This product includes a swing function, which helps provide relaxation for the area around your waist.

► APP DOWNLOAD AND INSTALLATION

Bluetooth connection instructions

Bluetooth connection via Apple iOS differs slightly from Android. Please see the details below on how to connect Apple iOS devices:

Apple iOS:

1. Open App store  at the top right corner input keywords like "SMART CHAIR-X3" to find the APP. Download Apple's application to your device. In the APP, open Bluetooth and connect with the massage chair. Reminder: Your Apple device must have Bluetooth 4.0 to connect with the massage chair. Please see the picture below. Click "GET" at the top right corner, users can download and fix the searched software.

2. Open "SMART CHAIR-X3" Enter into APP program. At first connection, please input your Apple ID user name and code. After successfully registering, click on "settings," choose "Bluetooth" and connect your device with the chair.

Bluetooth

- This product has Bluetooth connectivity for some audio devices.
Open Bluetooth on your device, match with SMART CHAIR-X3 to Play music on your chair.
- There is an extra audio input cable for other audio devices next to the controller socket. (Optional)